

Quick Installation Guide Megapixel Day&Night IP Camera

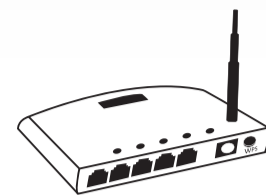

Installation Guide

Package Contents

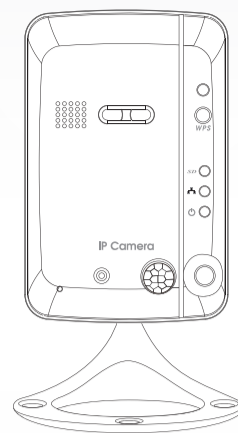
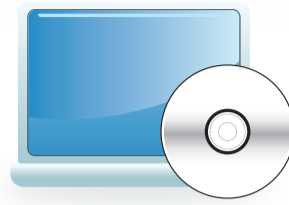
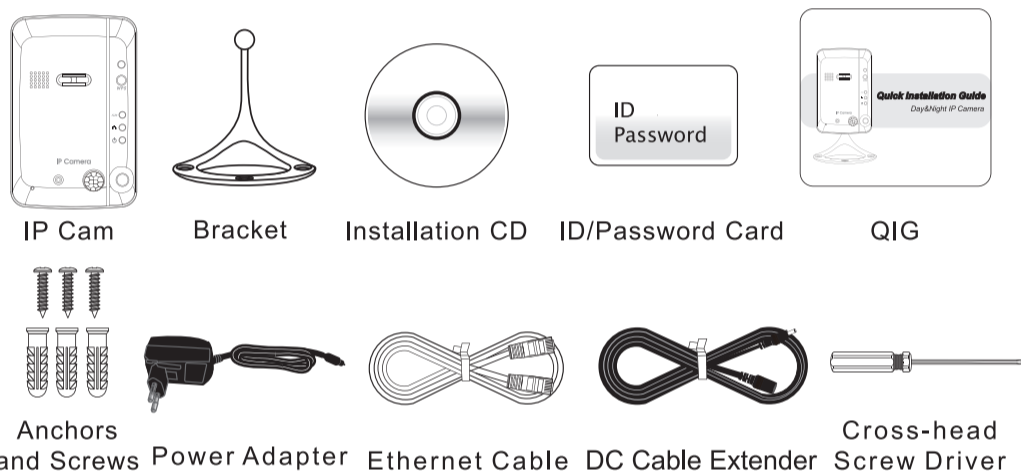

Step 1.

Connect IP Cam to Internet

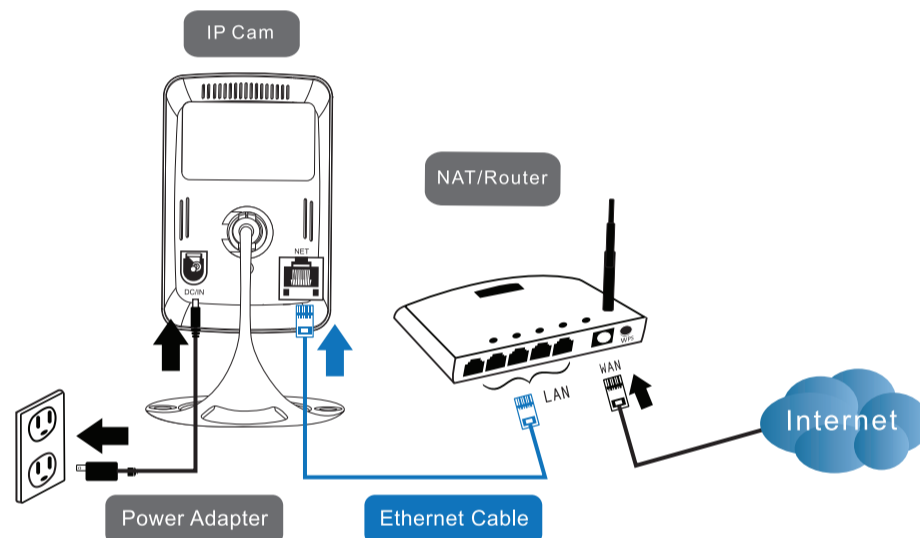

1. Connect the power adapter.
2. Connect the Ethernet cable to the NAT/Router.
3. The IP camera will get IP address from the NAT/Router (with DHCP enabled) automatically and connect to internet. Check if the red LED of IP camera is always on. If it's blinking, please check step 1 and step 2 again.

Hardware Installation

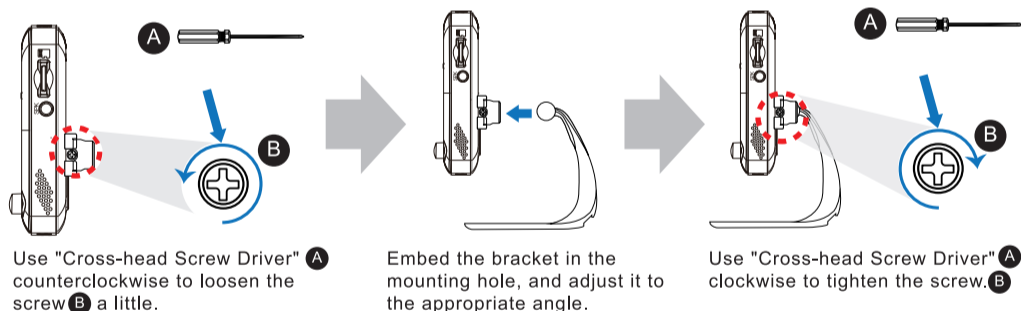

Use "Cross-head Screw Driver" **A** to loosen the screw **B** a little.

Embed the bracket in the mounting hole, and adjust it to the appropriate angle.

Use "Cross-head Screw Driver" **A** clockwise to tighten the screw **B**.

Product View

[Front View]

[Right Side View]

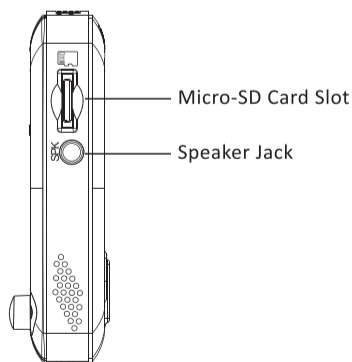
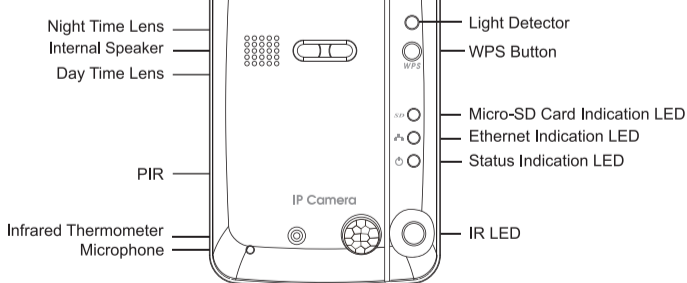

[Back View]

[Bottom View]

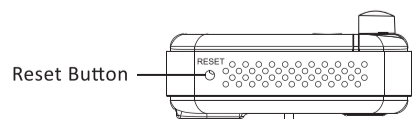
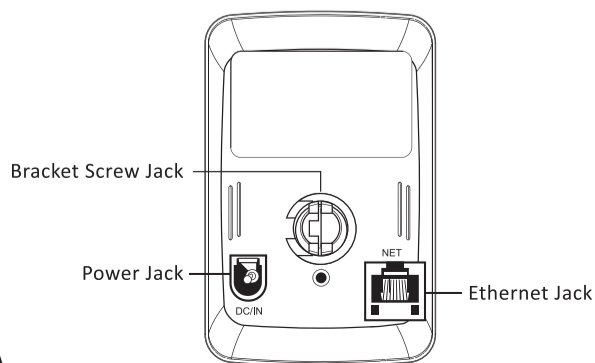

Step 2.

Install CamView Software



Installation CD

Put the Installation CD into your computer (with Windows XP/Vista/7). After the setup menu opened, select "Install Management Software" and follow the directions as prompted.

Step 3.

CamView Software Usage



1. Execute the installed CamView software on the desktop or from "Start → Programs → CamView → CamView".
2. The "Auto Search" will display the IP camera in the local network.
3. Double click the camera and key in the password on the ID/password card to see the video.

- ① You can drag the camera on the "Auto Search" area to the "Camera List" area.
- ② You could also add new item on the "Camera List" area by "Camera List" → "New Camera" → Key in camera ID and Password.

Step 4-2-2.

Wireless Setting of IP Cam - If no WPS on router

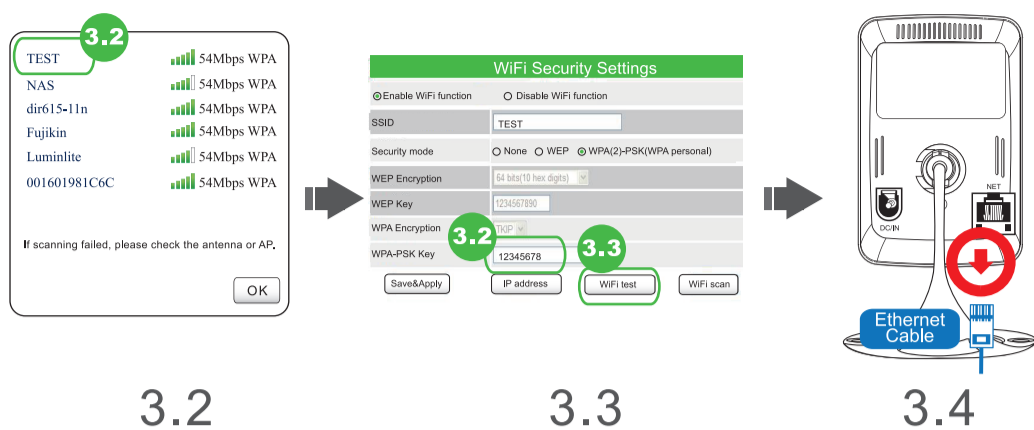

- 3.2 Choose the wireless AP and key in the encryption key.
- 3.3 Click "WiFi test" button and wait for 20~40 seconds to verify if the encryption key is correct. If "WiFi test" failed, check "encryption key" and repeat step 3.1 and step 3.2 again.

⚠ Please do not remove the Ethernet cable during WiFi test.

- 3.4. If the "WiFi test" succeeded, remove the Ethernet cable from the IP camera to start the wireless connection.

⚠ The blue LED and red LED will be always on after wireless connection is successful.

Step 4-1.

Wireless Setting of IP Cam - If router has WPS button

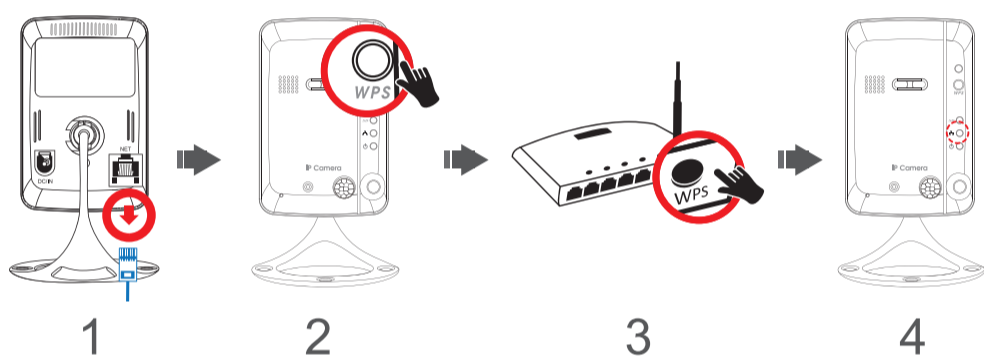

1. Remove the Ethernet cable from the camera.
2. Press the WPS button on the IP camera.
3. Press the WPS button on the NAT/Router.
4. The blue LED on the IP camera will start blinking. If the blue LED stops blinking and is always on in one minute, the wireless network is connected successfully.

Step 5.

Software for iPhone/iPad and Android mobiles

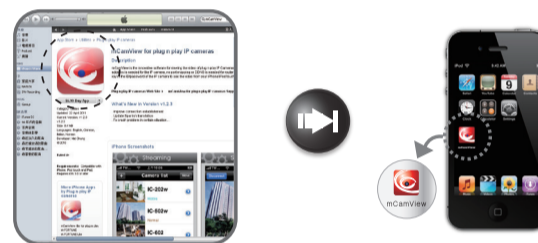

Please search the software name "mCamView" on the App Store for iPhone/iPad or on Android Market for Android mobiles.

Step 4-2-1.

Wireless Setting of IP Cam - If no WPS on router

⚠ Please make sure the Ethernet cable is connected to the IP Cam !

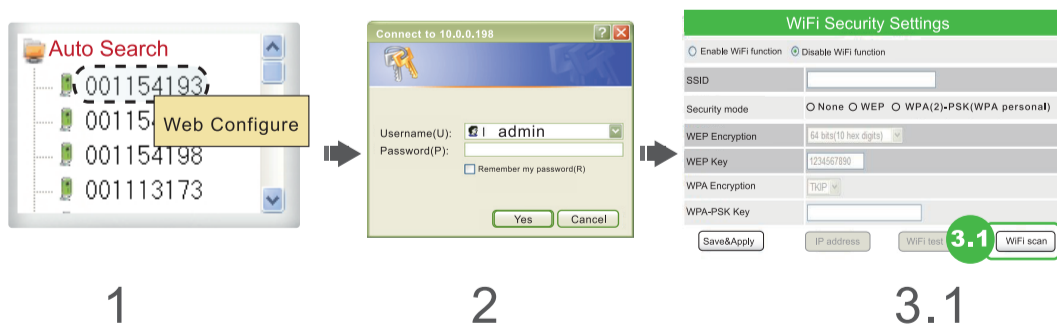

1. Right click camera on the "Auto Search" area and click "Web Configure".
2. Key in the admin account and password to enter the web configuration page.
3. Four steps to setup the wireless connection:
 - 3.1 Click the "WiFi Scan" button, all the available wireless AP will be listed in 10 seconds.

⚠ The default admin account is "admin", and no password.

FAQs

- Q1. What should I do if I forgot the password or the ID/Password card is missing?
Please press the "reset" button for five seconds. The IP camera will be reset to the factory default settings. The default admin account is "admin", and no password. The default video-play password is "ipcam".
- Q2. How could I use IE browser to see the live video?
Please visit <http://www.starvedia.com/live.html> and key in the Cam ID and password on the ID/Password card to see the live video.
- Q3. What should I do if I cannot see the video remotely?
The red LED of the IP camera should be always on when the IP camera is connected to the Internet. If the red LED is blinking, please double check the network connection and settings again.
- Q4. Where to download the latest CamView software?
Please download the latest CamView software with the following information :
Website: <http://www.starvedia.com/download.html>
Username: viewer
Password: camview

Note: SD Speed Class 10 is more recommended for SD card recording.

More FAQs, please visit www.starvedia.com/FAQ01_list.html

Note

Warning

FCC Compliance Statement:

This equipment has been tested and found to comply with limits for a Class B digital device, pursuant to Part 15 of the FCC rules. These limits are designed to provide reasonable protection against harmful interference in residential installations. This equipment generates, uses, and can radiate radio frequency energy, and if not installed and used in accordance with the instructions, may cause harmful interference to radio communications.

However, there is no guarantee that interference will not occur in a particular installation. If this equipment does cause interference to radio or television equipment reception, which can be determined by turning the equipment off and on, the user is encouraged to try to correct the interference by one or more of the following measures:

-Reorient or relocate the receiving antenna -Move the equipment away from the receiver-Plug the equipment into an outlet on a circuit different from that to which the receiver is connected.

-Consult the dealer or an experienced radio/television technician for additional suggestions. You are cautioned that any change or modifications to the equipment not expressly approved by the party responsible for compliance could void Your authority to operate such equipment.

This device complies with Part 15 of the FCC Rules. Operation is subjected to the following two conditions

- 1) This device may not cause harmful interference.
- 2) This device must accept any interference received, including interference that may cause undesired operation.

FCC Caution: Any changes or modifications not expressly approved by the party responsible for compliance could void the user's authority to operate this equipment.

This transmitter must not be co-located or operating in conjunction with any other antenna or transmitter.

For Mobile Device Usage Radiation Exposure Statement:

This equipment complies with FCC radiation exposure limits set forth for an uncontrolled environment. This equipment should be installed and operated with minimum distance 20cm between the radiator & your body.