

Setup the camera from a Smartphone/Tablet

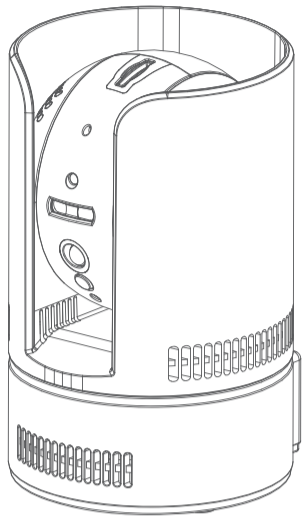

Supported Smart phone system version

- iOS iPhone 、 iPad
Requires iOS 6.0 or later
- Android Smart phone 、 Tablet
Requires Android 4.0 or Later

Download the mCamView2 user manual here <http://www.starvedia.com/download.html>

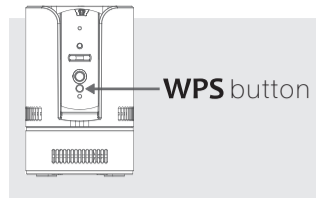

Press the WPS Button

Press the WPS Button on the Camera. The LEDs will start flashing.

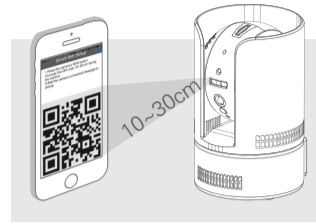

Scan the QR Code

Place your mobile about 10-30cm away from the camera. The camera will beep when the QR code is successfully scanned. It will flash the LEDs and start the WiFi connection.

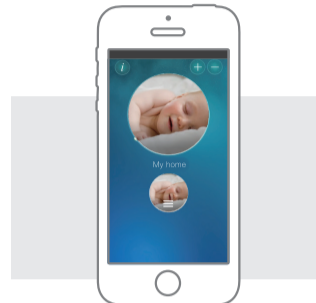

WiFi Connection is Established

When the WiFi connection is established, the blue LED will be flashing and the red LED will remain on. The new icon for this camera will be created on the App.

STEP 1 Download the mCamView2 APP



mCamView2

Scan the QR code to download the software "mCamView2" from App Store for iPhone/iPad or from Android Market for Android devices.

STEP 2 Power on the Camera

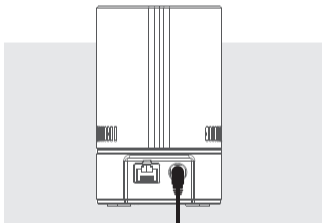

Connect the Power Adapter to the Camera
Do not connect the Ethernet cable.

STEP 3-1 WiFi Setup



Mobile Connected to 2.4G Hz WiFi
Make sure your iPhone/Android mobile is connected to a 2.4G Hz WiFi router, this is the must.

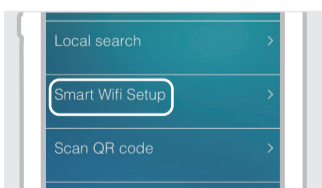

Smart WiFi Setup
Open the App mCamView2, tap the "+" icon to add the camera, choose "Smart WiFi setup" to setup the camera with WiFi connection.



Generate QR Code
Follow the steps and enter the WiFi password to generate a QR code.

STEP 4 Log in to the Camera

Tap the Camera icon to log in to the camera. The default administration account is "admin", the default administration password is empty (leave blank).

After logged in, tap the camera icon to play the live video.

* Notice : there are two passwords for the camera, one is the administration password, the other one is the video play password. The default video-play password is "ipcam" (lowercase).

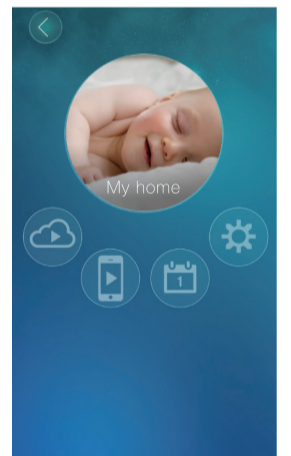
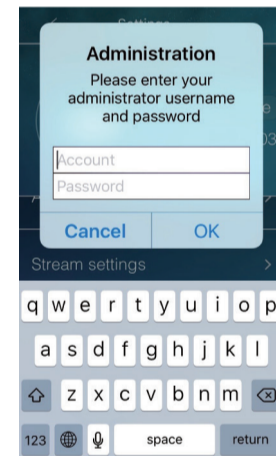
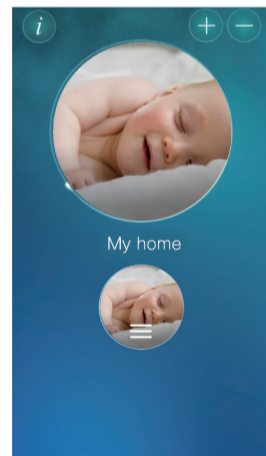

STEP 5 SD Card Recording * Class 10 micro SD is prerequisite

- Insert the SD card into the camera, the yellow LED on the camera will be blinking.
- The SD card will start to do the recording once the alarm notification is triggered. The camera will do 5 second pre-recording to prevent the loss of the important starting moment.
- To enable the continuous SD card recording, please enable it inside the camera settings.
- To playback the recorded video, tap the  on the App and choose the "SD Card" and date/time to do the playback.

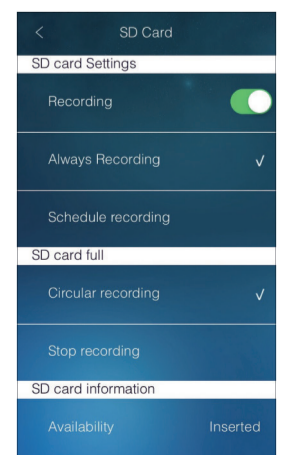
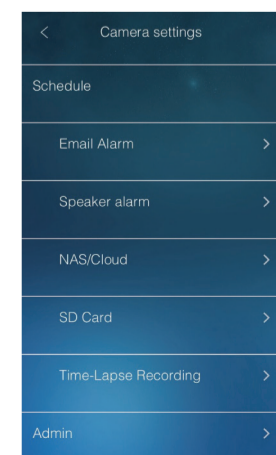
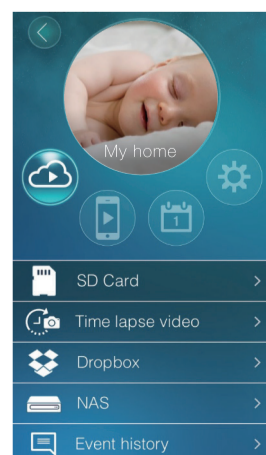

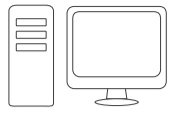

Setup the camera from a computer

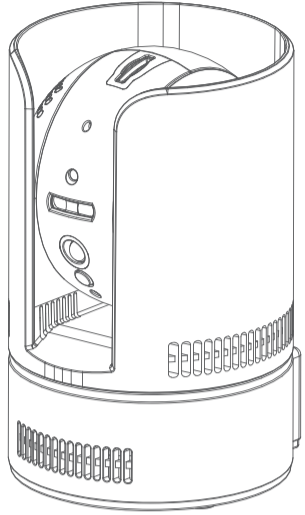

Computer system version

- Windows
Requires Windows XP or later
- MAC OS
Requires Mac OS 10.7 or later

Download the CamView user manual here
<http://www.starvedia.com/download.html>



• If No WPS on Router

If the router has no WPS function, please follow STEP 1 and make sure the Ethernet cable is connected to the Camera and then follow the steps below to setup the wireless connection.



5.1 Web Configure

On the camview software, right click on the camera you want to setup on the "Auto Search" area and click on "Web Configure". Enter the admin username and password.

The default admin username: admin.
 The default password is empty (leave blank)



5.2 Wireless Connection Settings

Click the "Network" → "WiFi Security".
 Click on the "Wi-Fi Scan" button, Choose the wireless AP.
 (If the scan failed, please check the antenna or the Wi-Fi Access Point.)

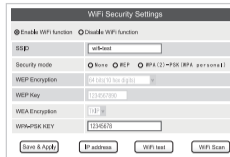

5.3 Wireless Connection Settings

Choose the wireless AP and key in the encryption key, click on the "Wi-Fi test" button. If the test has succeeded, please press "Save & Apply" and go to the next step.

Please do not unplug the Ethernet cable during the Wi-Fi test. If the test has failed, please go back to the step 5.2.

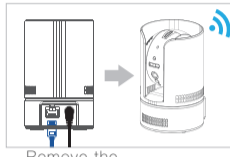

5.4 Unplug the Ethernet Cable from the Camera to start the Wireless Connection

If the Wi-Fi test has been successful, unplug the Ethernet cable from the camera. The red and blue LEDs will remain on once the wireless connection is operational.

The Wireless connection will not function if you do not remove the Ethernet cable from the camera.

STEP 1 Wired Connection

- Connect the power adapter.
- Connect the Ethernet cable to the NAT/Router.
- The IP Camera will get an IP address from the NAT/Router (with DHCP enabled) automatically. Check if the red LED of the IP camera is always on. If it's blinking, please check step A and step B again.

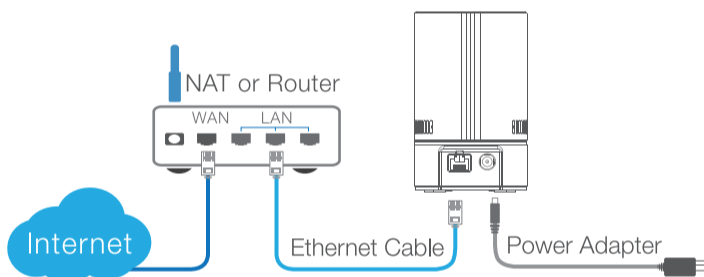

STEP 2 Install CamView Software

Please download the latest CamView software at this address :
<http://www.starvedia.com/download.html>

After the setup menu pops up, select "Install Management Software" and follow the instructions.



STEP 3 See The Video

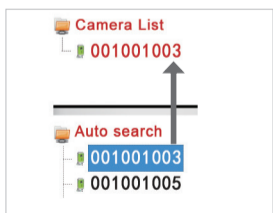

The CamView software will list the searched camera on the "Auto search" section. Drag the camera from the "Auto Search" section to the "Camera List" section.

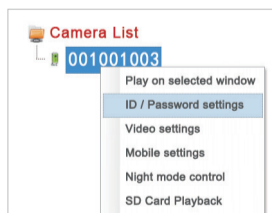

Right click the camera on the camera list and choose the ID/Password Settings.

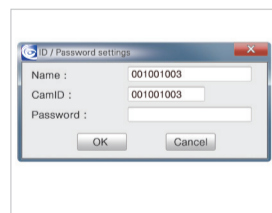

Key-in the password given on the ID/Password Card and then you will be able to see the video.

STEP 4 WiFi Setup

• If Router Has WPS Button

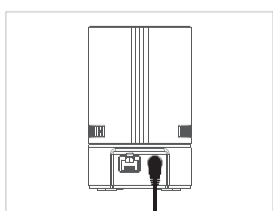

Unplug the Ethernet cable from the camera.

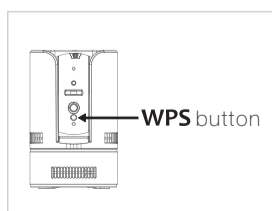

Press the WPS button on the camera.

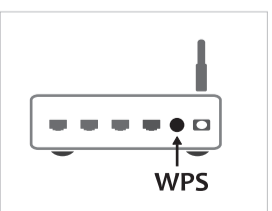

Press the WPS button on the NAT/Router, the LEDs on the IP Cam will start blinking. If the LEDs stops blinking and remain on, the wireless connection has been established successfully.

STEP 6 SD Card Recording * Class 10 micro SD is prerequisite

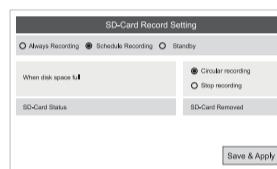

Enable SD card recording.
 → SD Card Record Settings on the Web configuration page. Then select "schedule recording" and the SD card recording will be operational right after saving.

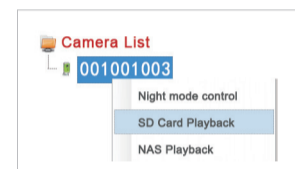

SD Card Playback. Right Click on the selected camera on the camera list, then choose the SD card playback.

FAQs

- Q1** What should I do if I have forgotten the password or the ID/Password card is missing?
Ans Please press the Reset button for five seconds. The camera will reset to the factory default settings. The default video-play password is ipcam (lowercase).
- Q2** What should I do if I cannot see the video remotely?
Ans The red LED of the camera should remain on when the camera is connected to the Internet. If the red LED is blinking, please double check the network connection and settings again.
- Q3** I can see the video from a remote location, but the video quality is not satisfying and sometimes the video disconnects and reconnects by itself.
Ans It's probably due to the poor Internet bandwidth (internet speed), which might be not good enough. You may try to apply for a better Internet connection from your Internet Service Provider or reduce the bandwidth setting of the camera.
- Q4** What is the default admin user name/password?
Ans Default admin user name: admin
 Default admin password: _____ (leave blank)
- Q5** Where to download the latest camView software?
Ans Please refer to the following website to download the latest CamView software.
www.starvedia.com/download.html

Package Contents

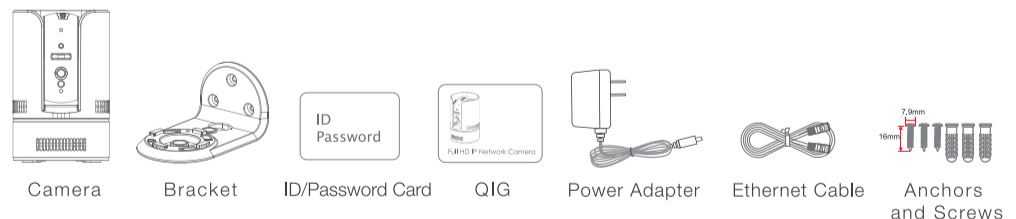

Product View

